

Roller Blind Systems

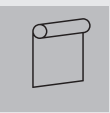



Chain Operated Roller Blind System

Silent Gliss® 4905

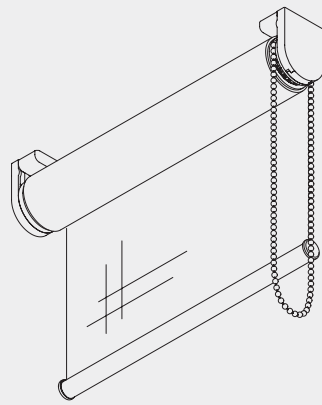

Product Information

- Small, chain operated roller blind system for residential as well as for contract applications.
- Extremely silent and smooth operation.
- Very comfortable and elegant operation with stainless steel bead chain. The blind can be stopped at any given position.
- System can be easily clicked into brackets due to click-in brackets.
- Side guide option available.
- The system 4905 can be used up to a maximum width of 1.4 m (1.6 m with Colorama 1 and 2 fabric), a maximum drop of 3 m or a maximum surface of 4.2 m² (4.8 m² with Colorama 1 fabric).
- Ceiling, recess or wall fixing possible.
- System is available in 27 colours (plus silver) of the Colorama fabric range.
- Supplied ready assembled, made-to-measure with fabrics.
- Optional child safety device available



4905

Profile and Bending Information

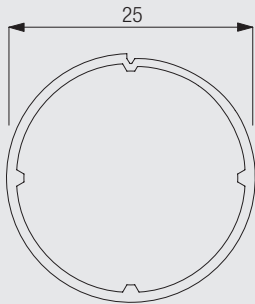

10533

How to Measure

Measurement information: single system

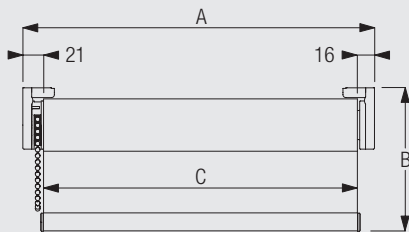

A: System width
B: System drop
C: Fabric width

Please note: measurements differ when side-guide option is used!

System Dimensions



4905



1.4 m
1.6 m*

*(only Colorama 1 and 2 fabric)



25 cm



3 m



4.2 m²
4.8 m²*

*(only Colorama 1 fabric)



1.3 kg (incl. bottom weight)

Please note: The max. system width/drop also depends on the fabric type.

Maximum system drop

Wall fitting:

Fabric thickness	mm	0.15	0.20	0.25	0.30	0.35	0.40	0.45	0.50	0.55
Max. system drop	cm	300	300	300	300	290	260	240	210	190

Ceiling fitting:

Fabric thickness	mm	0.15	0.20	0.25	0.30	0.35	0.40	0.45	0.50	0.55
Max. system drop	cm	300	300	300	300	300	300	290	260	240

System Options

Side guides for stabilising blind system and sloped applications (up to 15°)

Single system

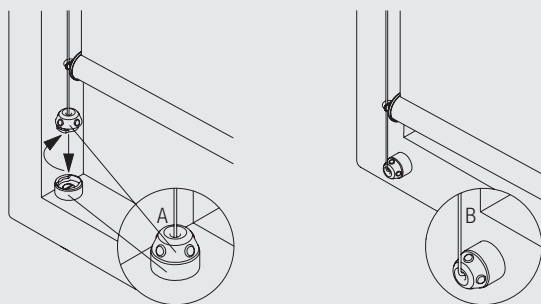

Double system

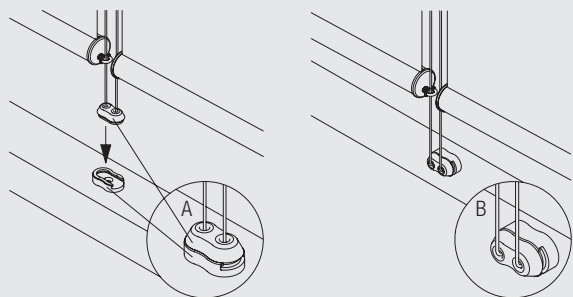

A: Fitting of side guides inside window frame
B: Fitting of side guides onto front of window frame

The system 4905 can be equipped with side-guide wires and can therefore also be used for sloped applications up to 15° inclination.

Child safety device

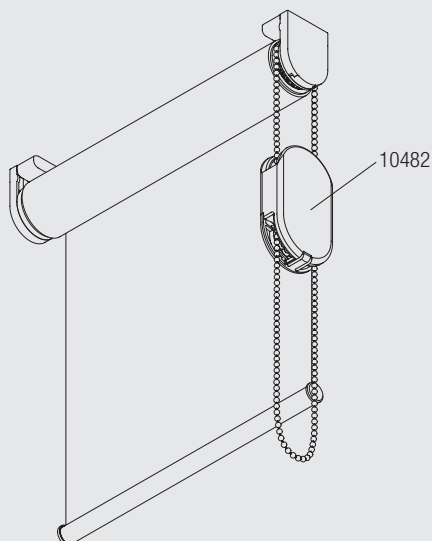

The child safety device SG 10482 releases the chain should the pulling force exceed 6 kg



4905

Fitting Information

Bracket positioning and basic fitting features

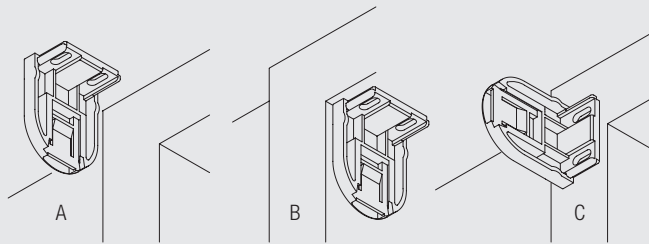

A: Ceiling Fixing
B: Recess Fixing
C: Wall Fixing

Easy loading and removal of the blind

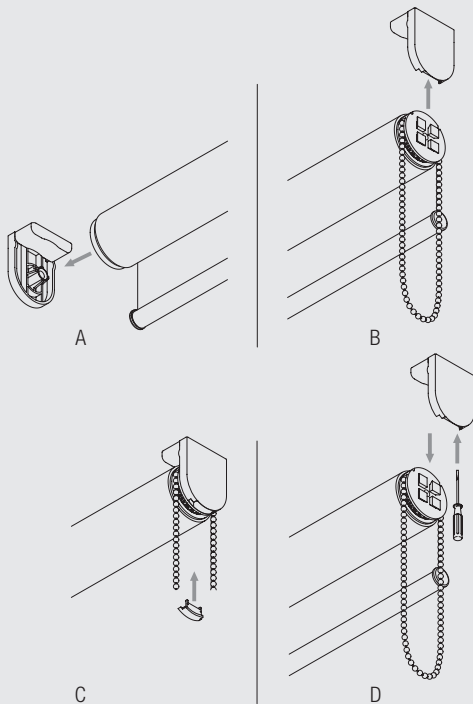

A: Insert roller blind into already mounted bracket support side
B: Click in roller blind into already mounted bracket chain side
C: Insert cover
D: Use small screw driver to remove roller blind

4905

Fitting Options

CAD download through Silent Gliss e-catalogue

Ceiling fitting

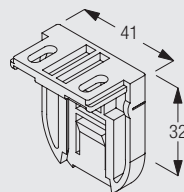
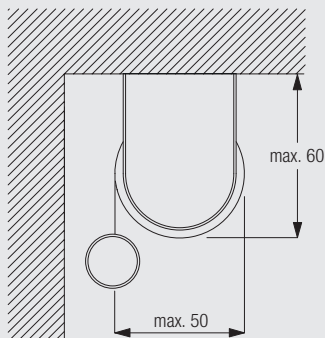

10679
Bracket chain side

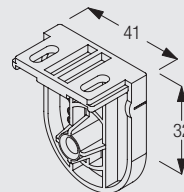

10680
Bracket support side

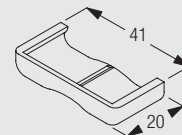

10683
Cover

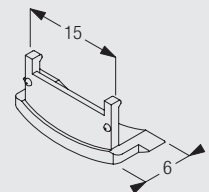

10684
Cover

All these measures are based on the maximum system dimensions.

Wall fitting

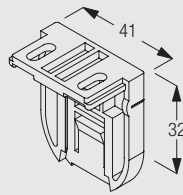
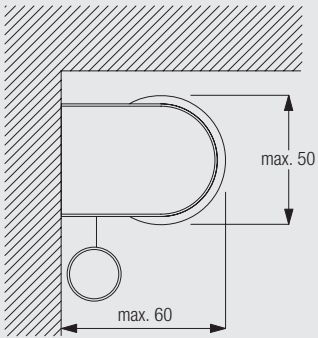

10679
Bracket chain side

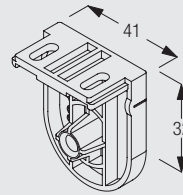

10680
Bracket support side

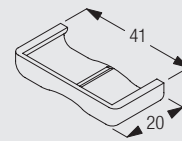

10683
Cover

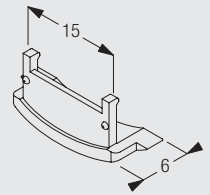

10684
Cover

All these measures are based on the maximum system dimensions.

Recess fitting

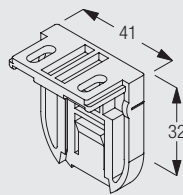
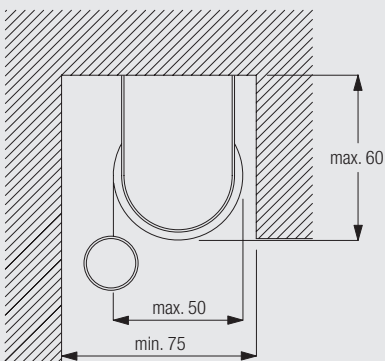

10679
Bracket chain side

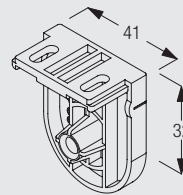

10680
Bracket support side

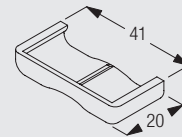

10683
Cover

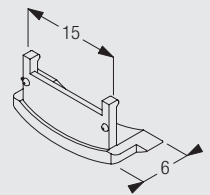

10684
Cover

All these measures are based on the maximum system dimensions.

Fitting with side guide option

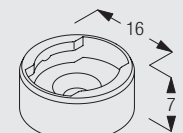
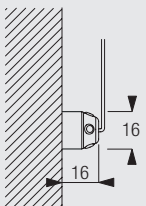
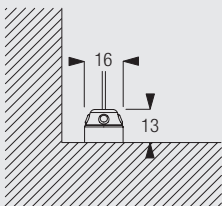

8235
Wire base short (side guide)

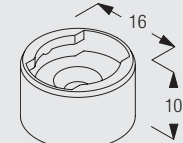

8236
Wire base long

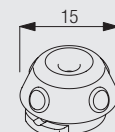

8237
Wire holder



4905

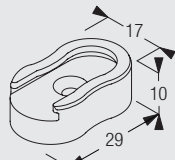
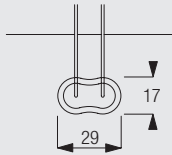
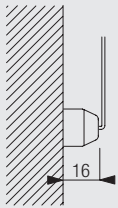
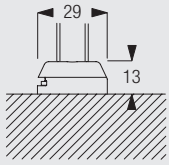

10669
Double base long
(side guide)

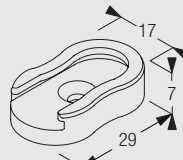

10673
Double base short
(side guide)

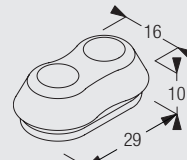

10701
Double wire holder
(side guide)

Standard Accessories

			4187	Strip	
4226	Double tape		10530	Stainless steel bead chain (ø 4 mm)	
10670	Chain drive		10679	Bracket chain side	
10680	Bracket support side		10681	Tube adapter	
10683	Cover		10684	Cover	
4905	Endcover round		10687	Weight bar	
10710	Chain drive		10731	Safety retainer set	

Optional Accessories

8235	Wire base short (side guide)		8236	Wire base long	
8237	Wire holder		8249	Device	
10482	Child safety device set		10643	Wire ø 1.3 mm x 4.2 m (side guide)	
10669	Double base long (side guide)		10673	Double base short (side guide)	
10676	Device		10686	End cover round (side guide)	
10701	Double wire holder (side guide)		10706	Wire ø 1.3 mm x 2.6 m (side guide)	

10709 Chain stop

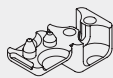

Useful Measures

10482 Child safety device set

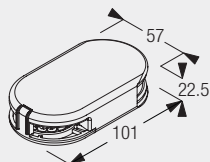

10643 Wire \varnothing 1.3 mm x 4.2 m (side guide)

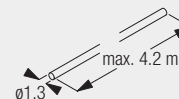

10685 Endcover round

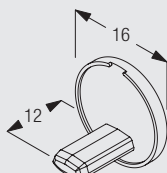

10687 Weight bar

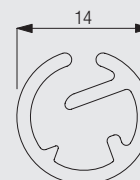

10706 Wire \varnothing 1.3 mm x 2.6 m (side guide)

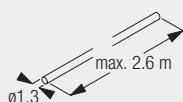

10731 Safety retainer set

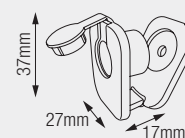

4905



4905



4905

www.silentgliss.at
www.silentgliss-russia.com
www.silentgliss-cee.com

Silent Gliss GesmbH
Jochen-Rindt-Straße 1
A - 1230 Wien

Tel. + 43 (0) 1 615 02 72
Fax. + 43 (0) 1 615 02 72-88

Silent Gliss GesmbH
Showroom/Export
Stubenring 6
A – 1010 Wien

Tel. +43 (0) 1 513 16 77
Fax. +43 (0) 1 513 16 77-88